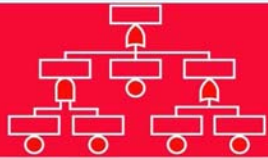

Chapter 3

System Analysis

Event Tree Analysis

Marvin Rausand

Department of Production and Quality Engineering
Norwegian University of Science and Technology
marvin.rausand@ntnu.no



Introduction

Consequence
spectrum

Barriers

What is ...?

Example

Applications

Construction

Example:
Separator

Quantitative
analysis

Conclusions

Introduction

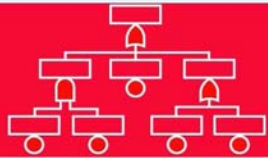

Consequence spectrum

Introduction
Consequence spectrum

Barriers

What is ...?

Example

Applications

Construction

Example:
Separator

Quantitative
analysis

Conclusions

An *accidental event* is defined as the first significant deviation from a normal situation that may lead to unwanted consequences (e.g., gas leak, falling object, start of fire)

An accidental event may lead to many different consequences. The potential consequences may be illustrated by a *consequence spectrum*

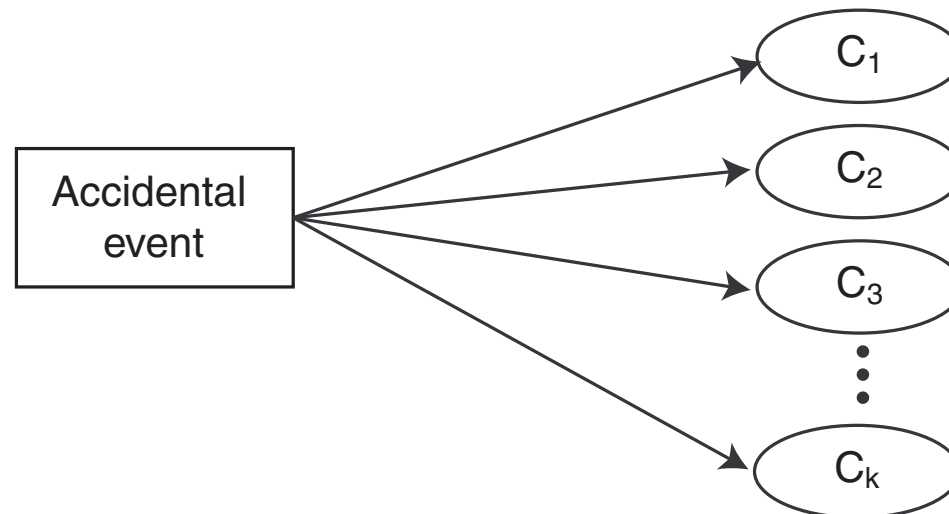

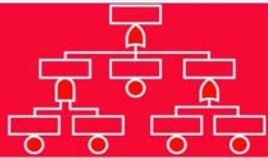

Barriers

Most well designed systems have one or more barriers that are implemented to stop or reduce the consequences of potential accidental events. The probability that an accidental event will lead to unwanted consequences will therefore depend on whether these barriers are functioning or not.

The consequences may also depend on additional events and factors. Examples include:

- Whether a gas release is ignited or not
- Whether or not there are people present when the accidental event occurs
- The wind direction when the accidental event occurs

Barriers are also called *safety functions* or *protection layers*, and may be technical and/or administrative (organizational). We will, however, use the term *barrier* in the rest of this presentation.

Introduction
Consequence spectrum

Barriers

What is ...?

Example

Applications

Construction

Example:
Separator

Quantitative analysis

Conclusions

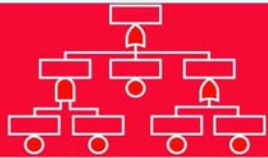

What is event tree analysis?

An event tree analysis (ETA) is an *inductive* procedure that shows all possible outcomes resulting from an accidental (initiating) event, taking into account whether installed safety barriers are functioning or not, and additional events and factors.

By studying all relevant accidental events (that have been identified by a preliminary hazard analysis, a HAZOP, or some other technique), the ETA can be used to identify all potential *accident scenarios* and sequences in a complex system.

Design and procedural weaknesses can be identified, and probabilities of the various outcomes from an accidental event can be determined.

Introduction
Consequence
spectrum
Barriers

What is ...?

Example
Applications

Construction

Example:
Separator

Quantitative
analysis

Conclusions

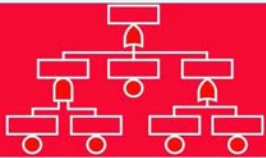

Example

Initiating event	Start of fire	Sprinkler system does not function	Fire alarm is not activated	Outcomes	Frequency (per year)
------------------	---------------	------------------------------------	-----------------------------	----------	----------------------

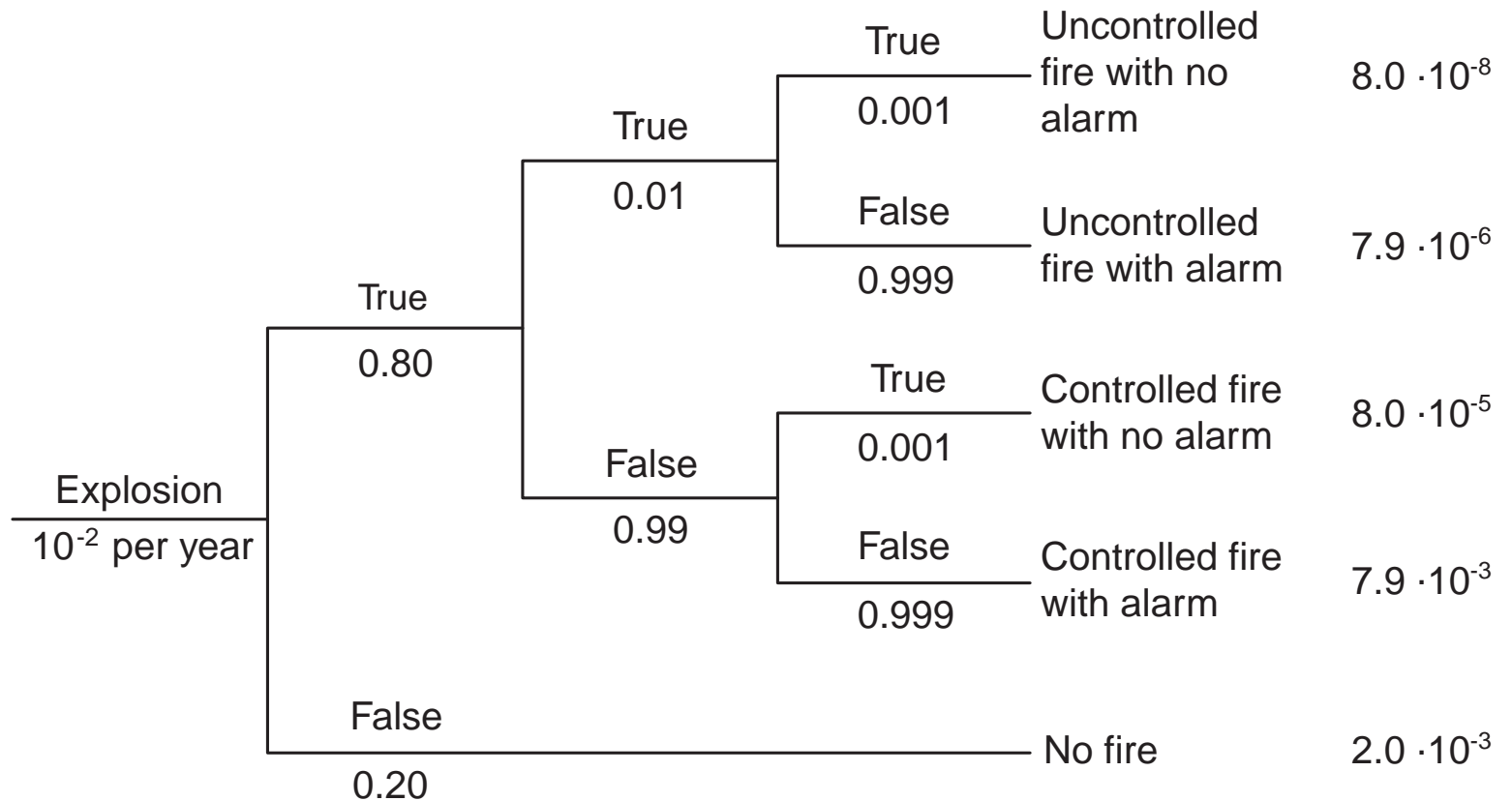

– Adapted from IEC 60300-3-9

- Introduction
- Consequence spectrum
- Barriers
- What is ...?

Example

Applications

Construction

Example:
Separator

Quantitative analysis

Conclusions

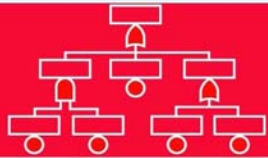

Applications

Introduction
Consequence
spectrum

Barriers

What is ...?

Example

Applications

Construction

Example:
Separator

Quantitative
analysis

Conclusions

- ❑ Risk analysis of technological systems
- ❑ Identification of improvements in protection systems and other safety functions

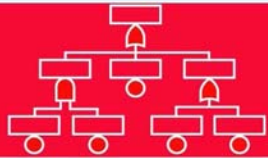

Introduction

Construction

Main Steps

Accidental event

Barriers

Event sequence

Outcome
alternatives

End outcomes

Example:
Separator

Quantitative
analysis

Conclusions

Event tree construction

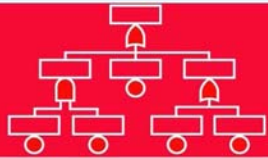

Main Steps

Introduction

Construction

Main Steps

Accidental event

Barriers

Event sequence

Outcome
alternatives

End outcomes

Example:
Separator

Quantitative
analysis

Conclusions

1. Identify (and define) a relevant accidental (initial) event that may give rise to unwanted consequences
2. Identify the barriers that are designed to deal with the accidental event
3. Construct the event tree
4. Describe the (potential) resulting accident sequences
5. Determine the frequency of the accidental event and the (conditional) probabilities of the branches in the event tree
6. Calculate the probabilities/frequencies for the identified consequences (outcomes)
7. Compile and present the results from the analysis

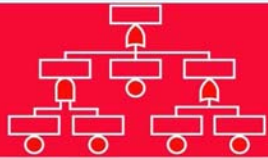

Accidental event

Introduction

Construction

Main Steps

Accidental event

Barriers

Event sequence

Outcome
alternatives

End outcomes

Example:
Separator

Quantitative
analysis

Conclusions

When defining an accident event, we should answer the following questions:

- ❑ What type of event is it? (e.g., leak, fire)
- ❑ Where does the event take place? (e.g., in the control room)
- ❑ When does the event occur? (e.g., during normal operation, during maintenance)

In practical applications there are sometimes discussions about what should be considered an accidental event (e.g., should we start with a gas leak, the resulting fire or an explosion). Whenever feasible, we should always start with the *first significant deviation* that may lead to unwanted consequences.

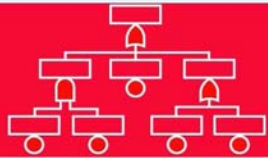

Accidental event

Introduction

Construction

Main Steps

Accidental event

Barriers

Event sequence

Outcome

alternatives

End outcomes

Example:
Separator

Quantitative
analysis

Conclusions

An accidental event may be caused by:

- System or equipment failure
- Human error
- Process upset

The accidental event is normally “*anticipated*”. The system designers have put in barriers that are designed to respond to the event by terminating the accident sequence or by mitigating the consequences of the accident.

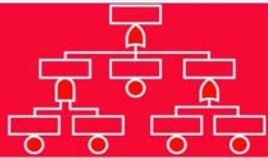

Accidental event

Introduction

Construction

Main Steps

Accidental event

Barriers

Event sequence

Outcome
alternatives

End outcomes

Example:
Separator

Quantitative
analysis

Conclusions

For each accidental event we should identify:

- The potential accident progression(s)
- System dependencies
- Conditional system responses

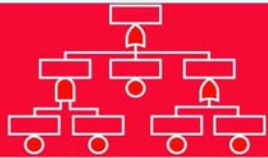

Barriers

Introduction

Construction

Main Steps

Accidental event

Barriers

Event sequence

Outcome
alternatives

End outcomes

Example:
Separator

Quantitative
analysis

Conclusions

The barriers that are relevant for a specific accidental event should be listed in the sequence they will be activated.

Examples include:

- Automatic detection systems (e.g., fire detection)
- Automatic safety systems (e.g., fire extinguishing)
- Alarms warning personnel/operators
- Procedures and operator actions
- Mitigating barriers

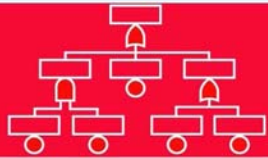

Additional events/factors

Introduction

Construction

Main Steps

Accidental event

Barriers

Event sequence

Outcome

alternatives

End outcomes

Example:

Separator

Quantitative
analysis

Conclusions

Additional events and/or factors should be listed together with the barriers, as far as possible in the sequence when they may take place.

Some examples of additional events/factors were given on a previous slide.

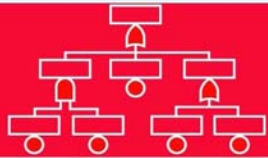

Event sequence

Each barrier should be described by a (negative) statement, e.g., “Barrier X does not function” (This means that barrier X is not able to performs its required function(s) when the specified accidental event occurs in the specified context).

Additional events and factors should also be described by (worst case) statements, e.g., gas is ignited, wind blows toward dwelling area.

	B ₁	B ₂	B ₃	B ₄	B ₅	
Accidental event	Additional event I occurs	Barrier I does not function	Barrier II does not function	Barrier III does not function	Additional event II occurs	Outcome / consequence

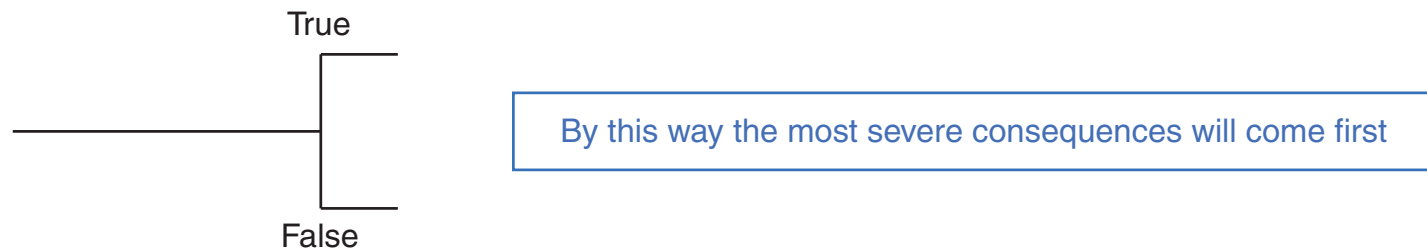

- Introduction
- Construction
- Main Steps
- Accidental event
- Barriers
- Event sequence**
- Outcome alternatives
- End outcomes
- Example: Separator
- Quantitative analysis
- Conclusions

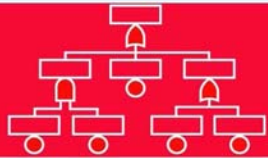

Outcome alternatives

In most applications only two alternatives (“true” and “false”) are considered. It is, however, possible to have three or more alternatives, as shown in the example below:

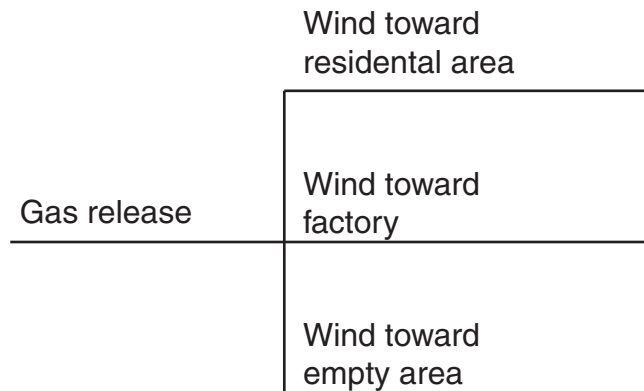

Introduction

Construction

Main Steps

Accidental event

Barriers

Event sequence

Outcome alternatives

End outcomes

Example: Separator

Quantitative analysis

Conclusions

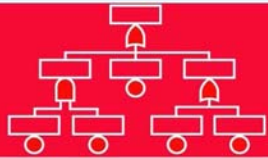

End outcomes

Introduction

Construction

Main Steps

Accidental event

Barriers

Event sequence

Outcome
alternatives

End outcomes

Example:
Separator

Quantitative
analysis

Conclusions

- ❑ In practice, many event trees are ended before the “final” consequences are reached
- ❑ Including these “final” consequences may give very large event trees that are impractical for visualization
- ❑ This is solved by establishing a consequence distribution for each end event and the probability of each consequence is determined for each end event
- ❑ In effect, this is an extension of the event tree, but it gives a more elegant and simpler presentation and also eases the summary of the end results

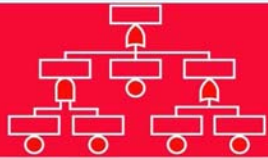

Results in decision making

Introduction

Construction

Main Steps

Accidental event

Barriers

Event sequence

Outcome

alternatives

End outcomes

Example:

Separator

Quantitative
analysis

Conclusions

The results from the event tree analysis may be used to:

- Judge the acceptability of the system
- Identify improvement opportunities
- Make recommendations for improvements
- Justify allocation of resources for improvements

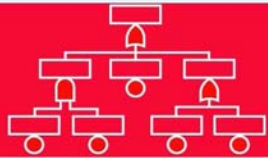

End events

Introduction

Construction

Main Steps

Accidental event

Barriers

Event sequence

Outcome alternatives

End outcomes

Example:
Separator

Quantitative analysis

Conclusions

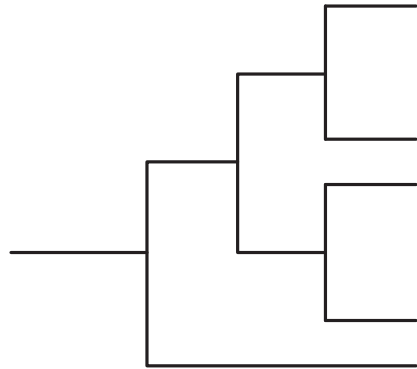

Out- come descr.	Freq- uency	Loss of lives					Material damage				Environmental damage							
		0	1-2	3-5	6 - 20	> 20	N	L	M	H	N	L	M	H				

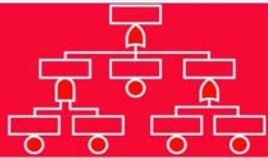

Introduction

Construction

**Example:
Separator**

Offshore separator

Event tree

Quantitative
analysis

Conclusions

Example: Separator



Offshore separator

Introduction

Construction

Example:
Separator

Offshore separator

Event tree

Quantitative
analysis

Conclusions

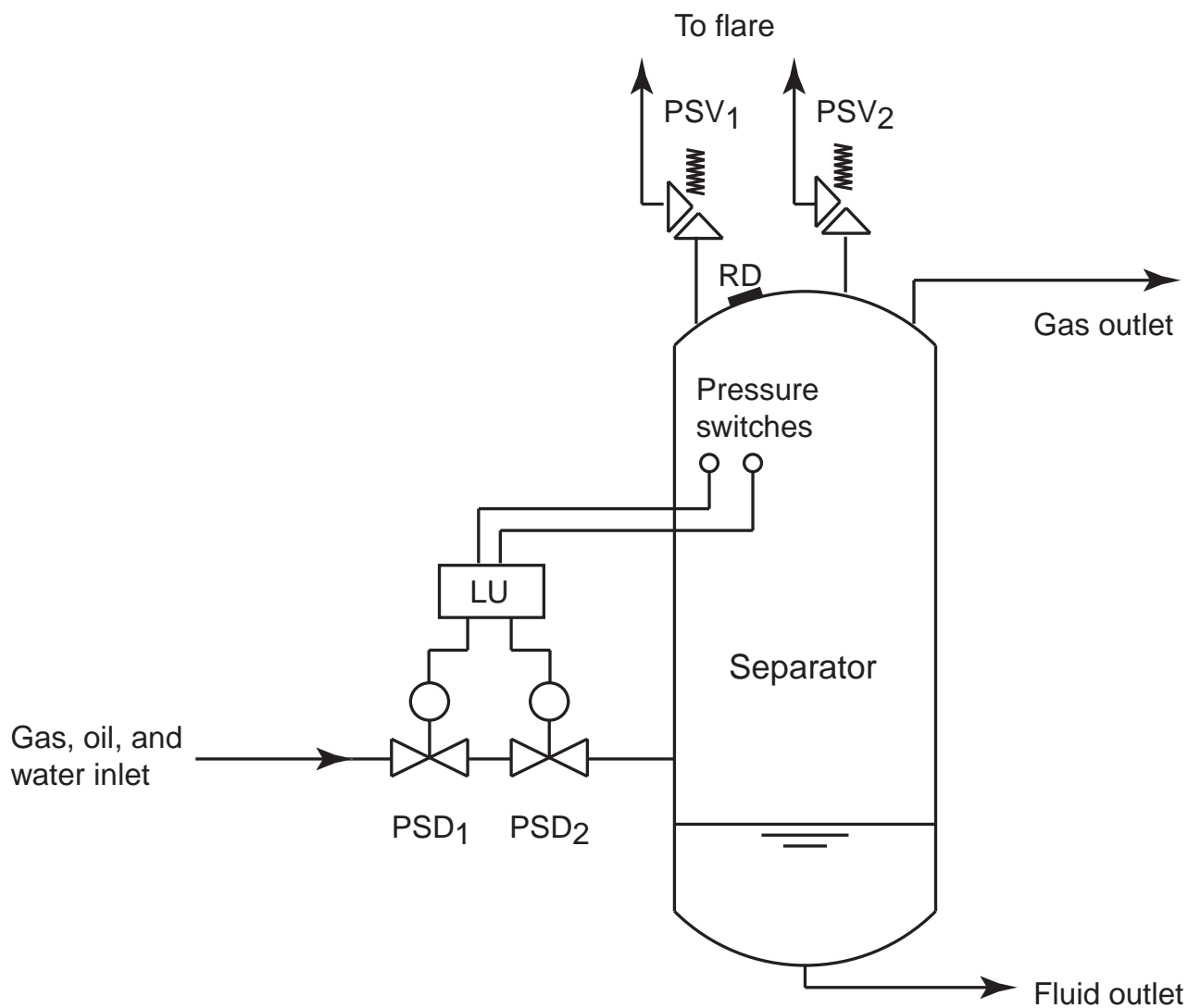

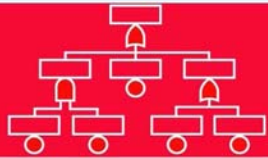

Activation Pressures

Introduction

Construction

Example:
Separator

Offshore separator

Event tree

Quantitative
analysis

Conclusions

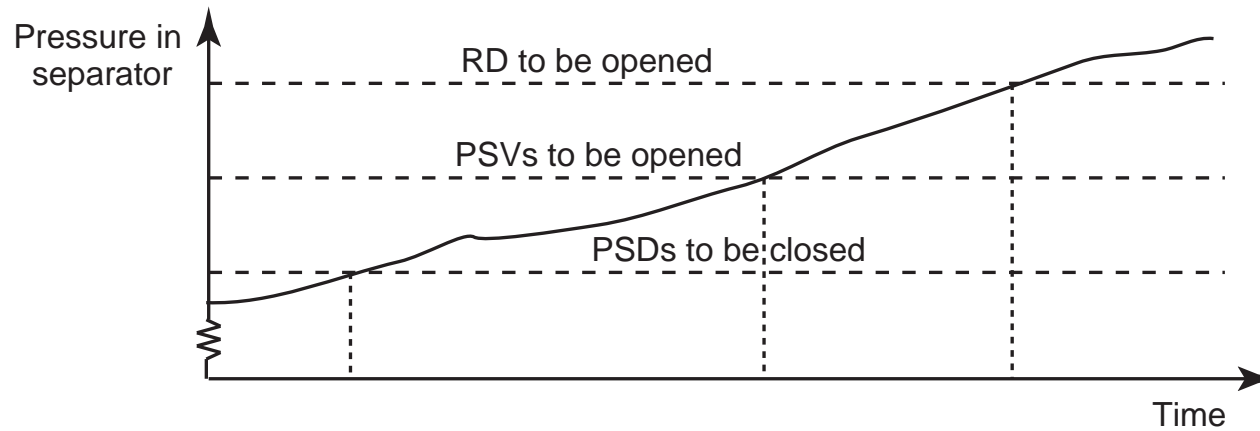

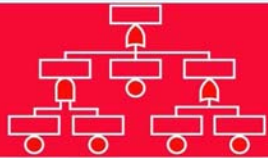

Event tree

Introduction

Construction

Example:
Separator

Offshore separator

Event tree

Quantitative
analysis

Conclusions

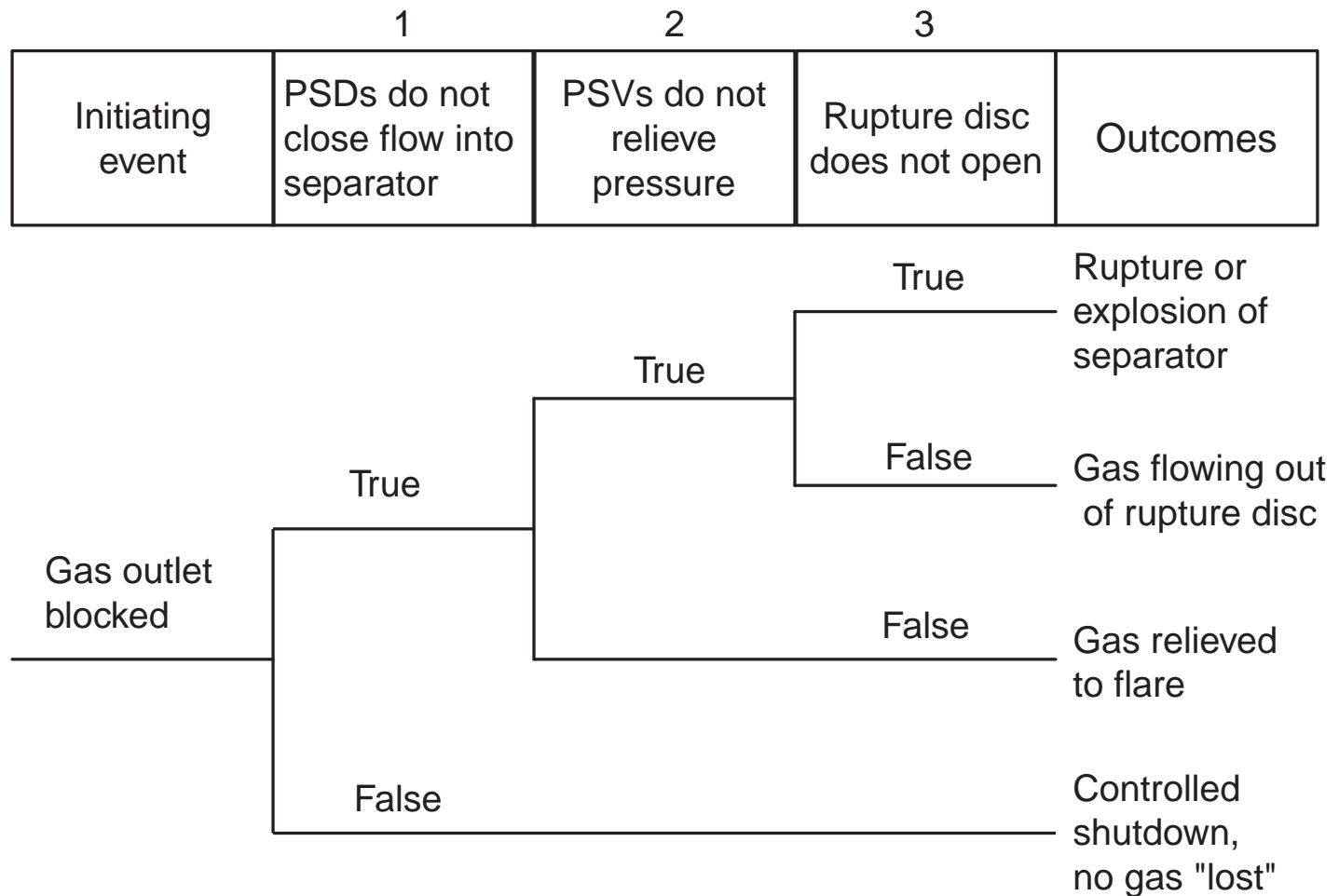

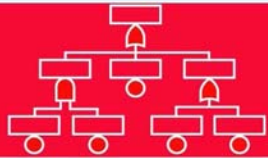

Introduction

Construction

Example:
Separator

**Quantitative
analysis**

Example
Frequencies of
outcomes

Conclusions

Quantitative analysis

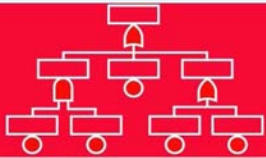

Example

Consider the generic example:

	B ₁	B ₂	B ₃	B ₄	
Accidental event	Additional event I occurs	Barrier I does not function	Barrier II does not function	Additional event II occurs	Outcome / consequence

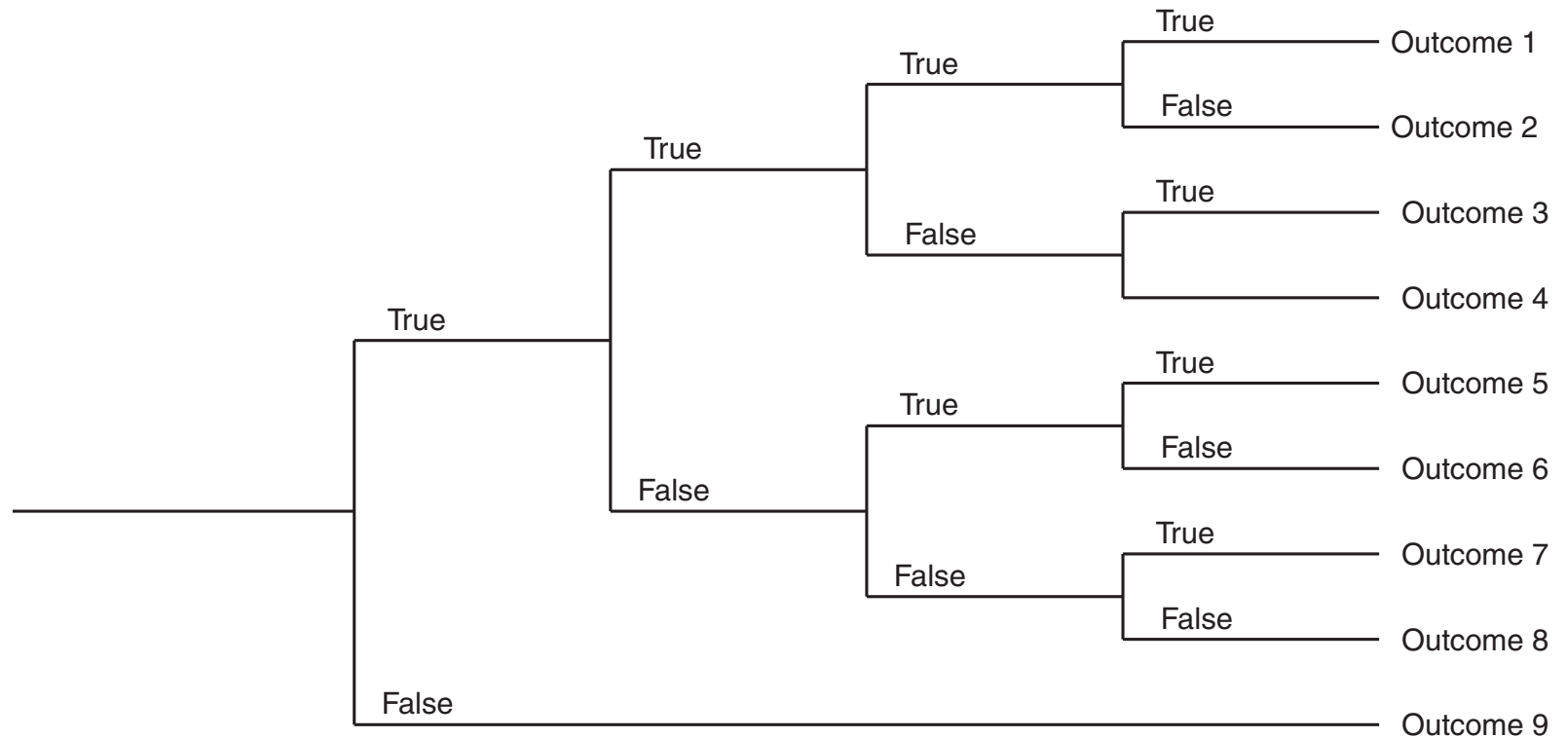

Introduction

Construction

Example:
Separator

Quantitative
analysis

Example

Frequencies of
outcomes

Conclusions

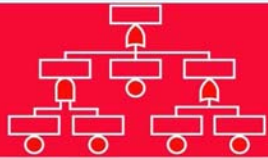

Frequencies of outcomes

Introduction

Construction

Example:
Separator

Quantitative
analysis

Example

Frequencies of
outcomes

Conclusions

Let λ denote the frequency of the accidental (initiating) event.
Let $\Pr(B_i)$ denote the probability of event $B(i)$.

When we know that the accidental event has occurred, the probability of “Outcome 1” is:

$$\begin{aligned}\Pr(\text{Outcome 1} \mid \text{Accidental event}) &= \Pr(B_1 \cap B_2 \cap B_3 \cap B_4) \\ &= \Pr(B_1) \cdot \Pr(B_2 \mid B_1) \cdot \Pr(B_3 \mid B_1 \cap B_2) \cdot \Pr(B_4 \mid B_1 \cap B_2 \cap B_3)\end{aligned}$$

Note that all the probabilities are conditional given the result of the process until “barrier” i is reached.

The frequency of “Outcome 1” is:

$$\lambda \cdot \Pr(B_1 \cap B_2 \cap B_3 \cap B_4)$$

The frequencies of the other outcomes are determined in a similar way.

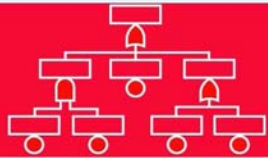

Introduction

Construction

Example:
Separator

Quantitative
analysis

Conclusions

Pros and cons

Conclusions

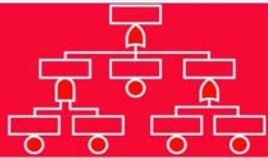

Pros and cons

Introduction

Construction

Example:
Separator

Quantitative
analysis

Conclusions

Pros and cons

Positive

- ❑ Visualize event chains following an accidental event
- ❑ Visualize barriers and sequence of activation
- ❑ Good basis for evaluating the need for new / improved procedures and safety functions

Negative

- ❑ No standard for the graphical representation of the event tree
- ❑ Only one initiating event can be studied in each analysis
- ❑ Easy to overlook subtle system dependencies
- ❑ Not well suited for handling common cause failures in the quantitative analyses
- ❑ The event tree does not show acts of omission